

OLYMPUS[®]

Your Vision, Our Future

Research Macro Zoom System Microscope

MVX10

MacroView

The First True Macro Fluorescence Imaging System



High-Precision Macro Fluorescence Imaging The MVX10 MacroView from Olympus

Researchers are interested in the impact of gene expression and protein function not only at the cellular level but also within whole tissues, organs and even organisms. Hence organisms like *C.elegans*, *Drosophila*, Zebrafish, Xenopus, Mouse or the plant *Arabidopsis* are used as biological models for *in vivo* studies in a vast field of research applications. The introduction of the naturally fluorescent protein makers, such as Green Fluorescent Protein (GFP), was a significant breakthrough since proteins can now be labelled without influencing their function.

Outstanding microscope for fluorescence observation in intact organisms must combine high detection sensitivity at low magnifications with a high magnification zoom for the resolution of fine details within organs, tissues and even cells. The Olympus MVX10 MacroView brings both of these factors together with many other unique features to bridge the gap between macro and micro observation, providing excellent brightness, resolution and precision.

- High fluorescence efficiency plus stereo observation
- Seamless observation from 4X to 125X
- Zoom factor up to 31 times
- Long W.D. for observation at optimum magnification
- High specimen protection due to short exposure time
- Complete system solutions for optimized recordings

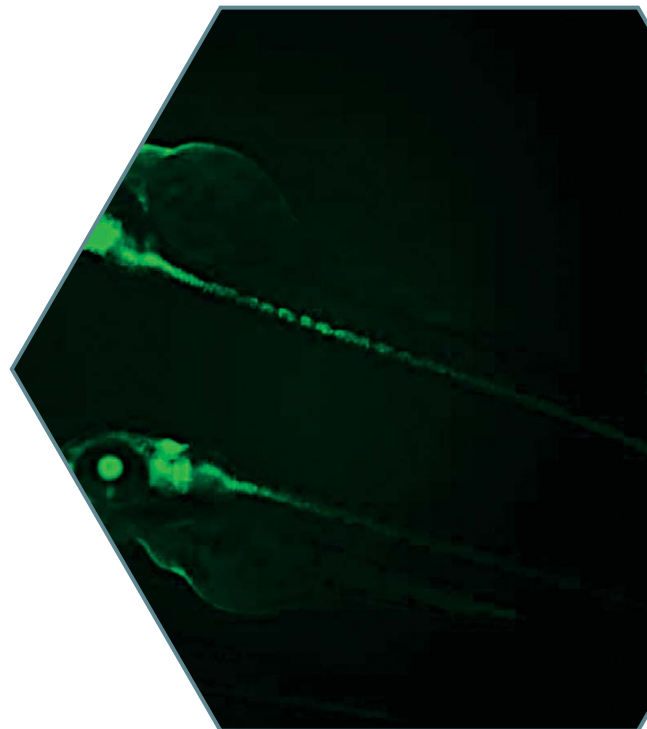

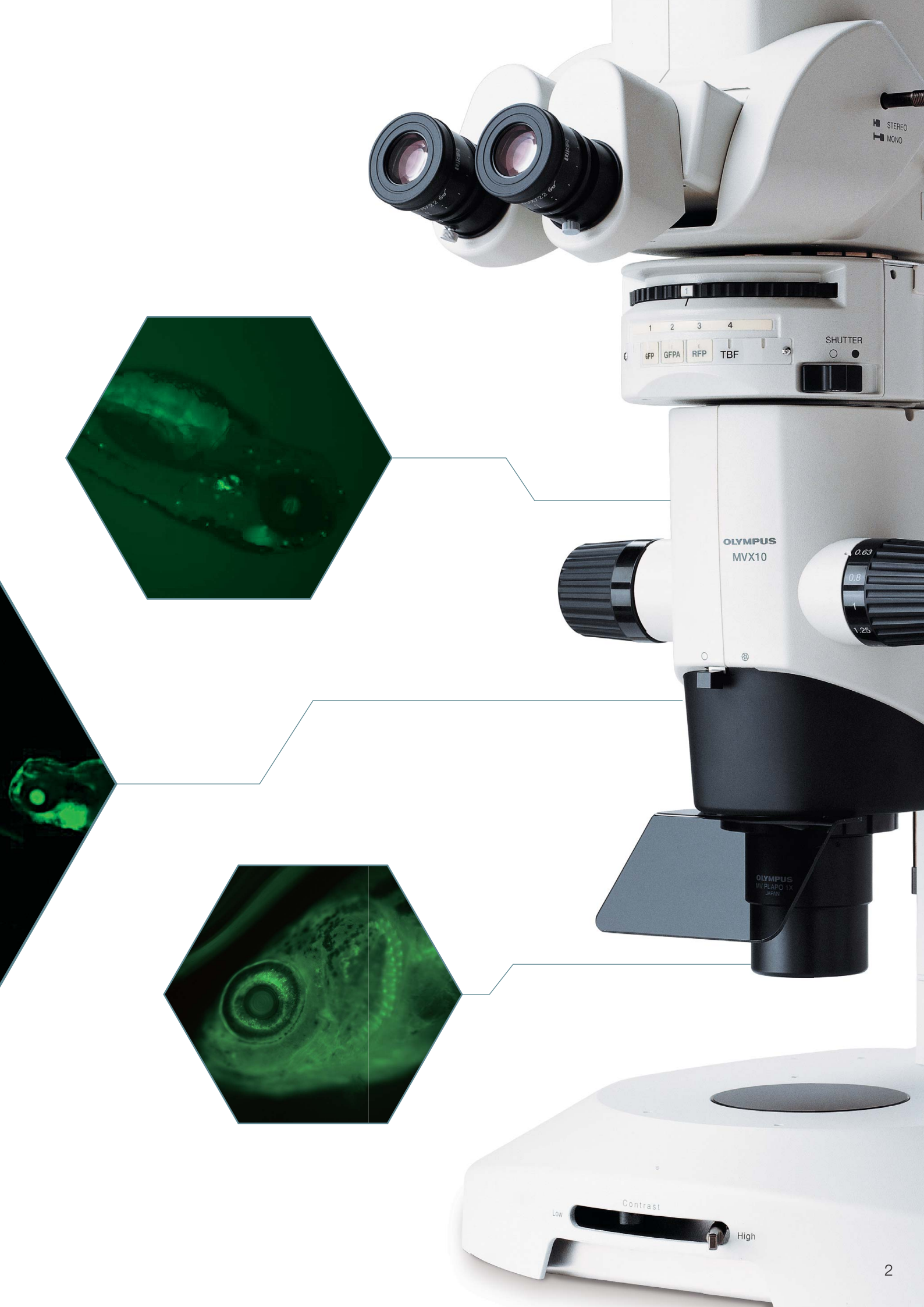

STEREO
MONO

1 2 3 4

BFP GFPA RFP TBF

SHUTTER

OLYMPUS
MVX10

0.63
0.8
1
1.25

OLYMPUS
W FLUORO TX
APPH

Contrast

Low

High

Bright Fluorescence Imaging with Seamless Macro to Micro Zooming

High Fluorescence Efficiency Plus Stereo Observation

Up until now, stereo microscopes have been the instruments of choice for fluorescence observation at low magnifications. For the stereoscopic effect, two optical paths are used—one for the left and one for the right eye. Stereo microscopy though, is not very well suited to imaging the weak light generated by fluorescence, since the light collected by the objective is split in two. The Olympus MVX10 MacroView on the other hand, employs a single-zoom optical path with a large diameter, which is optimized to collect light with revolutionary efficiency and resolution at all magnifications. From fluorescent observation of whole organisms such as zebrafish at low magnification to the detailed observation of gene expression at the cellular level at high magnification — the MVX10 helps you to see it all.

What's more, the MVX10 features a unique pupil division mechanism in the light-path to mimic the effect to stereo microscopy. So you can get the advantage of both worlds — high light efficiency and stereo observation — in one system just by moving a slider. This puts the MVX10 in a class of its own.

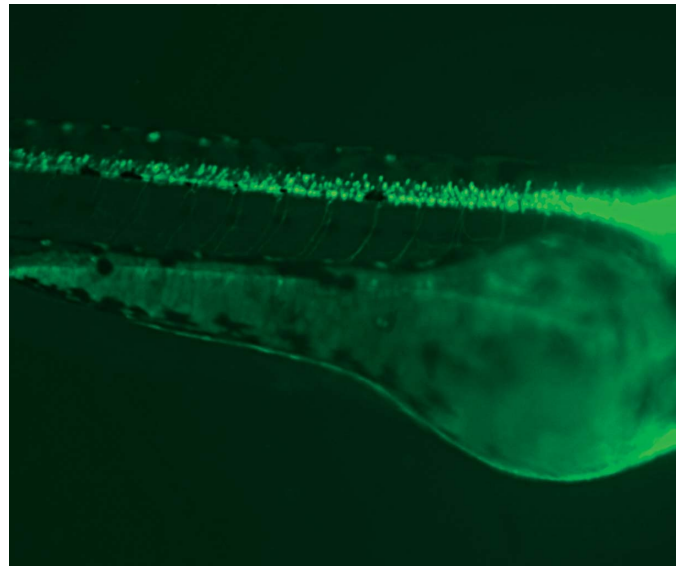

Zebrafish spinal cord expressing green fluorescent protein



Dedicated to Fluorescence

All components of the light path contribute to the phenomenal fluorescence performance of the MVX10. Using the latest technologies and new materials, the MVX10 objectives produce almost zero autofluorescence. Together with very high numerical apertures this results in an extremely good signal-to-noise (S/N) ratio, ensuring excellent contrast for observation of even the faintest fluorescence signals. Moreover, the S/N ratio is further enhanced by two novel proprietary features:

- A new coating technique gives the Olympus HQ filters an exceptional edge steepness and very low autofluorescence.
- All the filter cubes are equipped to absorb stray light.

Light collection efficiency is also optimized with an aspherical fluorescence collector, which bundles the light for low intensity loss.



Reflected light fluorescence unit + fluorescence mirror unit

Smooth and Parfocal Objectives for Seamless Observation from Macro to Micro

A Unique Objective Line

The MVX10 provides the same working distance and large field of view as stereo microscopes, but with much higher resolution due to the increased numerical aperture (NA). Specially designed for the MVX10, the 0.63X, 1X and 2X planapochromatic objectives produce high image quality. All three objectives are pupil-corrected for outstanding image flatness and show high transmission to NIR and excellent chromatic aberration correction. This provides great flexibility for efficient, fast and precise fluorescence observation, screening and imaging — from low to high magnification over time.

Dynamic

The 0.63X objective has a maximum field of view of 55mm, making it easy to track fast-moving specimens over time. With its exceptionally high NA of 0.15, fluorescence from large objects, such as whole embryos, can be viewed with outstanding brightness at all magnifications.

Gentle

The peerless NA and S/N ratio values of all the optical components mean that specimens can be expressed to fluorescent light for shorter periods. This is also true at near-infrared wavelength where the MVX10 has excellent transmission properties and thus fluorochromes throughout the entire spectrum can be used with minimal sample damage.

From Macro to Micro

Using the 2-position revolving nosepiece with the 0.63X and 2X objectives expands the usable zoom range up to 31. The objectives are parfocal corrected, making refocusing after objective switching very quick and easy. Only a small amount of fine focusing is necessary to return to the optical focus position, making macro to micro changes seamless. The 2X objective is also equipped with an additional correction collar to adjust the image quality independently of the specimen medium.



Objective lineup

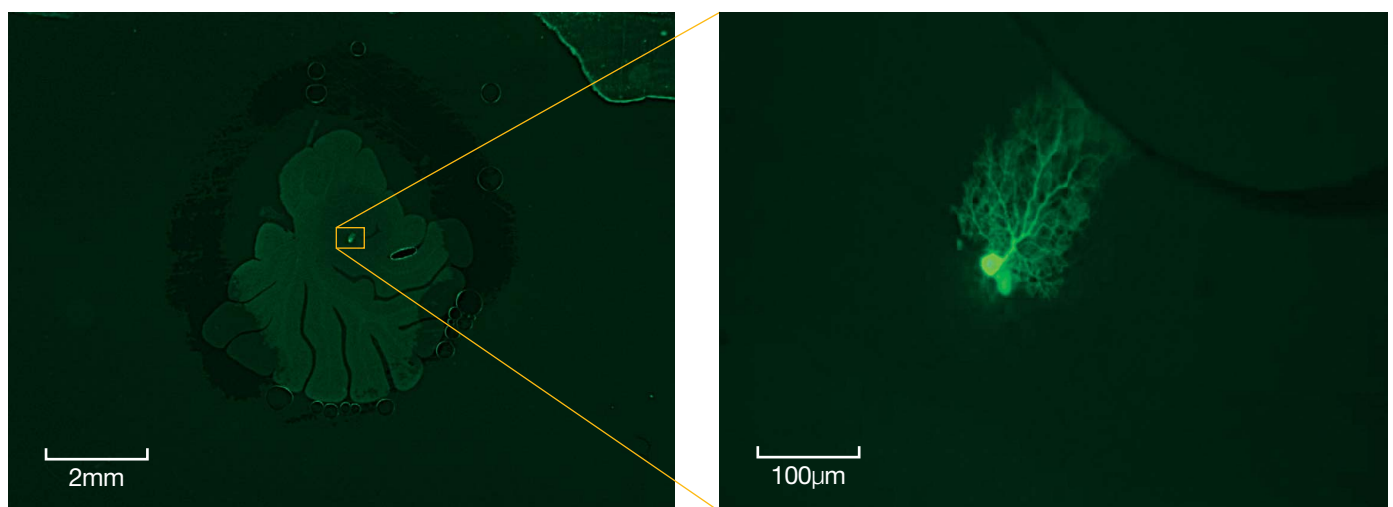

Purkinje cell of sliced mouse brain with Lucifer Yellow injected, at 0.63X (left) and 12.5X (right) magnification

Long Working Distance (W.D.) Ensures More Efficiency in Screening and Observation

In comparison with stereomicroscopes, the MVX10 provides the same working distance and a much higher NA (65mm W.D. and maximum 0.25 NA when using a 1X objective). This makes fluorescence screening and verification of gene expression especially efficient, improves speed and precision, reduces judgment errors, and eliminates the need to switch back and forth between a stereomicroscope and inverted microscope.

Use MVX10 for Optical Membrane Voltage Recording - From Sample Preparation to Recording

With optimal fluorescence light throughput, the MVX10 is highly effective for optical membrane voltage recordings requiring the detection of minute changes in fluorescence. It can be used for optical recordings at high speeds and high signal-to-noise ratios as well as utilized in the preparation of brain slices, tissue blocks, isolated hearts, in vivo animals, and other biological specimens. The interchangeable fluorescence filter cube unit in the MVX10 enables recordings using various kinds of fluorescent probe.

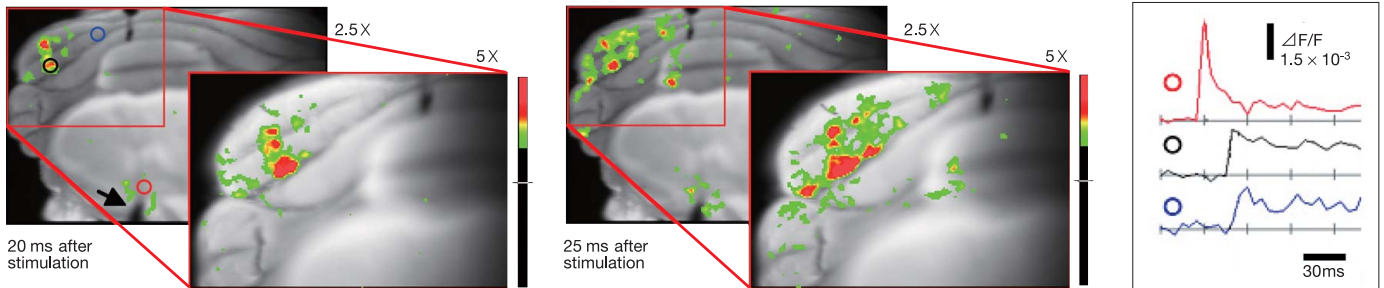

Optical Recording of Neuronal Circuits in Mice Cerebella

An isolated P7 mouse cerebellum was stained with membrane voltage-sensitive dye (Di-2 ANEPEQ, Invitrogen Corp.) The Principal Olive (Medial Accessory Olive) was stimulated to visualize the neuronal circuit structure. The images were acquired using the MVX10 (MVPLAPO 2XC and 6.3X Zoom) and a high-speed imaging system (MiCAM02-HR, Brainvision Inc.) at 200 frames per second, 192 X 128 pixels of spatial resolution, and 10 times averaging. Individual pixel size at this magnification is approximately 7-15 microns/pixel. The pseudo colors in the above image sample display both the intensity and propagation of electrical activity resulting from electrode stimulation of inferior olivary nuclei (indicated by arrow). The numbers above

the images represent zoom magnification, and the numbers below the images represent the time after stimulation. The waves (upper right) reflect the changes in fluorescence corresponding to the red-, black-, and blue-circled points on the image. The detailed structure of neuronal circuits can be recorded at high spatial and temporal resolutions using the MVX10 and membrane voltage-sensitive dye.

Dr. Akiko Arata

Laboratory for Memory and Learning, Neuronal Circuit Mechanisms Research Group
RIKEN, Brain Science Institute

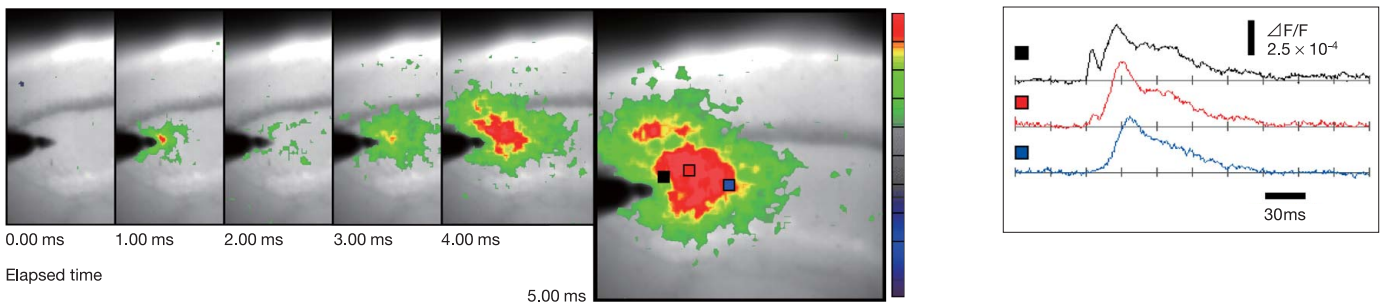

Optical Recording of Neural Activity with Membrane Voltage-Sensitive Dyes

These images show the propagation of neural activity in a mouse hippocampus slice (400-micron thickness) resulting from electrical stimulation in the Schaffer collateral region. Membrane voltage-sensitive dye (Di-4 ANEPPS, Invitrogen Corp.) was used to image the minute changes in fluorescence. The images were acquired using the MVX10 (MVPLAPO2 XC and 6.3X Zoom) and a high-speed imaging system (MiCAM ULTIMA-L, Brainvision Inc.) at 10,000 frames per second, 100 X 100 pixels of spatial resolution, and 6 times averaging. Individual pixel size at this magnification is approximately 8 microns/pixel.

The pseudo colors in the above image sample display both the intensity and propagation of electrical activity resulting from electrode stimulation. The numbers below the images represent frame numbers and time after stimulation. The waves reflect the changes in fluorescence corresponding to the red-, black-, and blue-squared points on the image. Optimal signal-to-noise ratios can be recorded at extremely high speeds with MVX10.

Dr. Yuko Sekino and Dr. Akihiro Fukushima

Division of Neuronal Network, Department of Basic Medical Sciences
The Institute of Medical Science, University of Tokyo

Illuminators for Various Observation Methods

High-Level Transmitted Light Illumination Base SZX2-ILLB

This illumination base provides optimal contrast adjustment for detailed observation of transparent specimens. With a single action, the user can select a "high" or "low" contrast setting. Oblique illumination is also provided.



Large Stand SZX2-STL

This stable stand with large base provides a broad working space for observing large specimens. Attaching the Motorized Focus Unit (SZX2-FOA) creates a more comfortable work environment.



MVX10 specifications

Zoom microscope body MVX-ZB10	Zoom	Mono-zoom variable magnification system		
	Zoom ratio	1:10 (0.63X-6.3X)		
	Aperture iris diaphragm	Built-in		
Observation tube MVX-TTRS	Features	Tilting trinocular head that allows switching between standard and stereo observation		
	Field number (FN)	22		
	Tilting angle	0° -23° continuously variable system		
	Light path selection	2-step binocular 100%/photo 100%		
Reflected light fluorescence unit MVX-RFA	Illumination mode	Coaxial reflected light		
	Filter selection	Turret 3 filter + BF		
	Fluorescence mirror unit	For CFP, GFP, YFP, RFP separation high quality mirror unit For GFP and GFP separation mirror unit		
	Light source	130W high-pressure mercury light source with fiber, 100W mercury apo lamp housing and power source, 100W mercury lamp housing and power source, or 75W xenon apo lamp housing and power source		
Magnification changer MVX-CA2X	Magnification	1X, 2X selection		
Objectives (when used with eyepiece WHN10X-H)		MVPLAPO 0.63X	MVPLAPO 1X	MVPLAPO 2XC
	Total magnification	4.0X-40X	6.3X-63X	12.5X-125X
	Working distance W.D. (mm)	87	65	20
	Numerical Aperture (NA)	0.15	0.25	0.5
	Field of view (mm)	55 - 5.5	34.9 - 3.5	17.6 - 1.7
Stand, Transmitted illumination bases	Stand, Transmitted illumination bases	High-level transmitted light illumination base SZX2-ILLB, Brightfield/darkfield illumination base SZX2-ILLD, Large stand SZX2-STL		
	Focusing unit	Fine focusing unit for heavy loading SZX2-FOFH, Motorized focusing unit SZX2-FOA		
	Stage	Large stage plate		

Dimensions

(unit: mm)

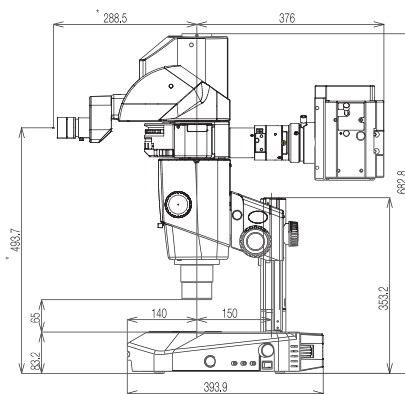
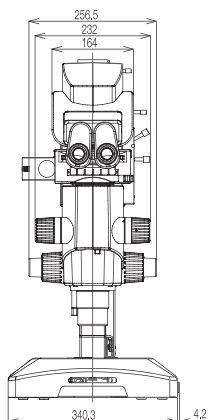

Weight: approx. 22 kg
Power consumption: 408 VA
The length marked with an asterisk (*) may vary depending on interpupillary distance and tilting angle.

Photo courtesy of: Chi-Bin Chien PhD, University of Utah (spread 1: top)
Richard Dorsky PhD, University of Utah (spread 1: left, spread 2: left)
Mark Ellisman PhD, Hiroyuki Hakozaaki MS, Natalie Maclean MS,
University of California, San Diego, NCMIR (spread 2: middle and right)
Dr. YH Leung, The University of Hong Kong (spread 1: bottom)

- OLYMPUS CORPORATION is ISO14001 certified.
- OLYMPUS CORPORATION is ISO9001 certified.
- Illumination devices for microscope have suggested lifetimes. Periodic inspections are required. Please visit our website for details.

- All company and product names are registered trademarks and/or trademarks of their respective owners.
- Specifications and appearances are subject to change without any notice or obligation on the part of the manufacturer.

www.olympus-lifescience.com

OLYMPUS[®]

For enquiries - contact

www.olympus-lifescience.com/contact-us

OLYMPUS CORPORATION

Shinjuku Monolith, 2-3-1 Nishi-Shinjuku, Shinjuku-ku, Tokyo 163-0914, Japan

OLYMPUS EUROPA SE & CO. KG

Wendenstrasse 14-18, 20097 Hamburg, Germany

OLYMPUS SCIENTIFIC SOLUTIONS AMERICAS CORP.

48 Woerd Avenue, Waltham, MA 02453, U.S.A.

OLYMPUS SINGAPORE PTE LTD.

491B River Valley Road, #12-01/04 Valley Point Office Tower, Singapore 248373

OLYMPUS MEDICAL SYSTEMS INDIA PRIVATE LIMITED.

102-B, First Floor, Time Tower, M.G. Road, Gurgaon 122001, Haryana, INDIA

OLYMPUS LATIN AMERICA, INC.

5301 Blue Lagoon Drive, Suite 290 Miami, FL 33126, U.S.A.

OLYMPUS (CHINA) CO., LTD.

A8F, Ping An International Financial Center, No. 1-3, Xinyuan South Road,

Chaoyang District, Beijing, 100027 P.R.C.

OLYMPUS KOREA CO., LTD.

8F Olympus Tower, 446 Bongeunsa-ro, Gangnam-gu, Seoul, 06153 Korea

OLYMPUS AUSTRALIA PTY. LTD.

3 Acacia Place, Notting Hill VIC 3168, Australia