

OPERATING INSTRUCTIONS AND SYSTEM DESCRIPTION FOR THE

PTC-20

PELTIER TEMPERATURE CONTROL SYSTEM



VERSION 4.0
npi 2017

npi electronic GmbH, Bauhofring 16, D-71732 Tamm, Germany
Phone +49 (0)7141-9730230; Fax: +49 (0)7141-9730240
support@npielelectronic.com; <http://www.npielectronic.com>

Table of Contents

1. Safety Regulations.....	3
2. PTC-20 Components	4
3. PTC-20 System.....	4
3.1. System Description.....	4
3.2. Description of the Front Panel.....	5
3.3. Rear Panel Elements.....	10
3.4. Electronic Control and Protection Circuits.....	10
3.5. Connection of Peltier Elements	11
3.6. Modes of Operation	11
3.7. Setting the DESIRED TEMPERATURE.....	13
4. Grounding.....	13
5. Temperature sensors / Block diagram	14
5.1. DIN Connector	14
5.1. Available sensors.....	15
5.2. Block diagram	16
6. Operating guide – Tuning procedure.....	17
6.1. PTC-20 and the HCMIS Micro-Incubator.....	19
Connection.....	19
Operation	19
6.2. Operation with HPT-2A Heated Perfusion Tube (discontinued)	20
7. Literature	20
8. Technical Data.....	21

1. Safety Regulations

VERY IMPORTANT: Instruments and components supplied by npi electronic are NOT intended for clinical use or medical purposes (e.g. for diagnosis or treatment of humans), or for any other life-supporting system. npi electronic disclaims any warranties for such purpose. Equipment supplied by npi electronic must be operated only by selected, trained and adequately instructed personnel. For details please consult the GENERAL TERMS OF DELIVERY AND CONDITIONS OF BUSINESS of npi electronic, D-71732 Tamm, Germany.

- 1) **GENERAL:** This system is designed for use in scientific laboratories and must be operated by trained staff only. General safety regulations for operating electrical devices should be followed.
- 2) **AC MAINS CONNECTION:** While working with the npi systems, always adhere to the appropriate safety measures for handling electronic devices. Before using any device please read manuals and instructions carefully.
The device is to be operated only at 115/230 Volt 60/50 Hz AC. Please check for appropriate line voltage before connecting any system to mains.
Always use a three-wire line cord and a mains power-plug with a protection contact connected to ground (protective earth).
Before opening the cabinet, unplug the instrument.
Unplug the instrument when replacing the fuse or changing line voltage. Replace fuse only with an appropriate specified type.
- 3) **STATIC ELECTRICITY:** Electronic equipment is sensitive to static discharges. Some devices such as sensor inputs are equipped with very sensitive FET amplifiers, which can be damaged by electrostatic charge and must therefore be handled with care. Electrostatic discharge can be avoided by touching a grounded metal surface when changing or adjusting sensors. **Always turn power off when adding or removing modules, connecting or disconnecting sensors, headstages or other components from the instrument or 19" cabinet.**
- 4) **TEMPERATURE DRIFT / WARM-UP TIME:** All analog electronic systems are sensitive to temperature changes. Therefore, all electronic instruments containing analog circuits should be used only in a warmed-up condition (i.e. after internal temperature has reached steady-state values). In most cases a warm-up period of 20-30 minutes is sufficient.
- 5) **HANDLING:** Please protect the device from moisture, heat, radiation and corrosive chemicals.

PELTIER ELEMENTS MUST BE MOUNTED ALWAYS ON APPROPRIATE HEAT SINKS TO AVOID DAMAGE THROUGH OVERHEATING.

2. PTC-20 Components

The following items are shipped with the PTC-20 system:

- ✓ PTC-20 controller
- ✓ Power cord
- ✓ User manual

Optional accessories:

- ⇨ COOLIT heat sink for heating and cooling devices
- ⇨ Miniature temperature sensor
- ⇨ Subminiature temperature sensor

Caution: The temperature sensors are very sensitive to mechanical stress, especially to bending. Therefore, they must be handled with great care to avoid breaking of the insulation!

- ⇨ PT 100 temperature sensor
- ⇨ HCMIS microincubator
- ⇨ HCPC heating/cooling perfusion cube
- ⇨ HCS heated chamber stage
- ⇨ HPC Heated perfusion cube
- ⇨ Thermal foil
- ⇨ Objective heater

3. PTC-20 System

3.1. System Description

The PTC-20 temperature control system is designed for heating and cooling purposes in electrophysiological experiments. The PTC-20 system provides two independent temperature controller channels and is housed in a 19 inch standard rackmount cabinet with built-in power supply and cooling elements for the power devices. The PTC-20 system guarantees low noise operation and has special protection features to prevent the preparation from damage.

The PTC-20 incorporates two channels which include an electronic thermometer for small semiconductor sensor (standard is R2252, i.e. the sensor has a resistance of 2252 Ω at 25 °C or optionally PT 100, i.e. 100 Ω at 0 °C), a digital temperature display (XX.X °C) for each channel, a set value control with direct readout (XX.X °C), a PI (proportional-integral) controller with adjustable parameters, an output power control unit and a high-power bipolar output stage (± 12 V DC, continuous operation) for Peltier elements (i.e. heat / cool operation) or resistive (i.e. heat only) loads with electronic protection circuits. For heat-only applications the bipolar output can be switched to unipolar operation (+12V). The power outputs are short circuit protected, the output power is limited electronically. Maximum output voltage is approximately 12 Volt, the current is limited to 3 A.

The system can be connected to the thermistors / heating/Peltier elements in two ways:

Using separate cables for the sensors and the heating element or

Using the ALA DIN cable assembly that connects both, sensors and heating/Peltier elements

A large variety of sensors and thermal elements are available (see also **Optional accessories** in chapter 2). Please contact npf for details.

Important: Peltier elements must be mounted always on appropriate heat sinks to avoid damage because of overheating.

3.2. Description of the Front Panel

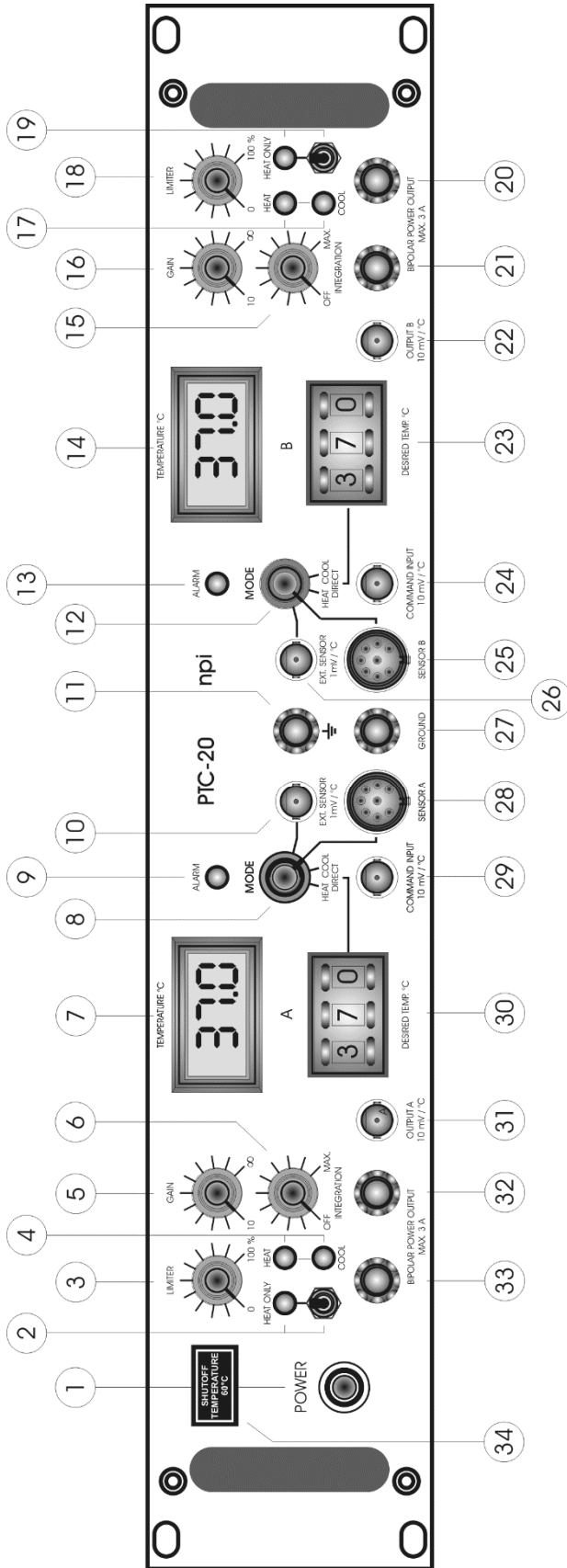

Figure 1: PTC-20 front panel view

In the following description of the front panel elements each element has a number that is related to that in Figure 1. The number is followed by the name (in uppercase letters) written on the front panel and the type of the element (in lowercase letters). Then, a short description of the element is given. Some elements are grouped in functional units (e.g. MODE of operation unit) and are described as units regardless of the order of numbers.

The PTC-20 has two temperature control channels with identical operation elements for channel A and channel B respectively. Thus, in the following description the elements are addressed first for channel A (bold) and second for channel **B** (bold, italic, underlined). Only the mode of operation unit is described separately for each channel.

(1) **POWER** pressure switch



Switch to turn POWER on (switch pushed) or off (switch released).

(2, **19**) **HEAT ONLY** LED, **HEAT ONLY** switch



The HEAT ONLY toggle switch sets the controller into HEAT ONLY mode ((**2**) for channel A, (**19**) for channel B). The red LED above the switch indicates the state of the controller (LED on = HEAT ONLY).

(3, **18**) **LIMITER** potentiometer



Potentiometer to set the voltage range of the POWER OUTPUT (**32/33** or **20/21**) of channel A or channel **B** (100% = 12 Volt).

(4, **17**) **HEAT / COOL** LEDs



LEDs that indicate the state of the POWER OUTPUT (**32/33** or **20/21**) of channel A or channel **B**.

HEAT (yellow LED): output polarity positive (“active” side will be heated, see also chapter 3.5)

COOL (green LED): output polarity negative (“active” side will be cooled, see also chapter 3.5)

(5, 16) GAIN potentiometer

Potentiometer (logarithmic scale) to change the GAIN parameter (amplification of the error signal, see chapter 3.4) of the temperature controller (PI controller) of channel **A** or **B**, range: 10 to ∞ .

(6, 15) INTEGRATION potentiometer

Potentiometer to set the INTEGRATION parameter (time constant) of the temperature controller (PI controller) of channel **A** or **B**, time range: 50 ms - 20 s.

(7, 14) TEMPERATURE °C display

Digital display that shows the temperature determined by SENSOR **A** or SENSOR **B**. resolution XX.X °C

MODE of operation unit channel A

The mode of operation unit of channel A consists of **(8)** MODE switch, **(9)** ALARM LED, **(10)** EXT.SENSOR 1mV / °C connector, **(28)** SENSOR A connector, **(29)** COMMAND INPUT 10mV / °C connector and **(30)** DESIRED TEMP./°C potentiometer.

(8) MODE switch

Switch to select the operation modes for channel A. Four modes are available:

- SENSOR A: the temperature determined by SENSOR A **(28)** is used for the control system
- DIRECT HEAT: the voltage at the POWER OUTPUT **(32/33)** can be set directly from the DESIRED TEMPERATURE potentiometer **(30)**, (0 to +12 V, no control)
- DIRECT COOL: the voltage at the POWER OUTPUT **(32/33)** can be set directly from the DESIRED TEMPERATURE potentiometer **(30)**, (0 to -12 V, no control)
- EXT. SENSOR: an external thermometer connected to BNC connector **(10)** (sensitivity 1mV/°C) can be used for the controller loop

(9) ALARM LED

LED that indicates that the temperature SENSOR A is not connected, broken or short-circuited. The POWER OUTPUT (**32/33**) shuts down if this LED is on and the MODE switch (**8**) is set to SENSOR A.

(10) EXT.SENSOR 1mV / °C connector

BNC connector for an external thermometer with a voltage output of 1mV/°C.

(28) SENSOR A connector

8-pole connector for temperature SENSOR A. This connector also provides the POWER OUTPUT (**32/33**) for the heating unit (max. $\pm 12\text{V DC}$ and 3A) for devices with the ALA DIN connector cable assembly. (e.g. HCMIS, see www.alascience.com).

(29) COMMAND INPUT 10mV/°C connector

BNC connector to set the working temperature of the controller system by an external voltage signal. This input is scaled with the factor 10mV / °C.

(30) DESIRED TEMP./°C potentiometer

Digital potentiometer to set the working temperature of the controller system for channel A, range: 02.0 °C to 60.0 °C, XX.X °C or 0-100% of output voltage (DIRECT mode).

(11) Protective earth / (27) GROUND connectors

To avoid ground loops the internal ground of the system is floating, i.e. it is not connected to the protective earth of the line cable while the cabinet is always connected via the power supply cable (green / yellow wire). The system can be grounded by connecting plug **(11)** protective earth or **(27)** internal ground.

MODE of operation unit channel B

The mode of operation unit of channel B consists of **(12)** MODE switch, **(13)** ALARM LED, **(26)** EXT.SENSOR 1mV / °C connector, **(25)** SENSOR B connector, **(24)** COMMAND INPUT 10mV / °C connector and **(23)** DESIRED TEMP./°C potentiometer.

(12) MODE switch

Switch to select the operation modes for channel B. Four modes are available:

- SENSOR B: the temperature determined by SENSOR B (**25**) is used for the control system
- DIRECT HEAT: the voltage at the POWER OUTPUT (**20/21**) can be set directly from the DESIRED TEMPERATURE potentiometer (**23**), (0 to +12 V, no control)
- DIRECT COOL: the voltage at the POWER OUTPUT (**20/21**) can be set directly from the DESIRED TEMPERATURE potentiometer (**23**), (0 to -12 V, no control)
- EXT. SENSOR: an external thermometer connected to BNC connector (**26**) (sensitivity 1mV/°C) can be used for the controller loop

(13) ALARM LED

LED that indicates that the temperature SENSOR B (**25**) is not connected, broken or short-circuited. The POWER OUTPUT (**20/21**) shuts down if this LED is on and the MODE switch (**12**) is set to SENSOR B.

(26) EXT.SENSOR 1mV / °C connector

BNC connector for an external thermometer with a voltage output of 1mV/°C.

(25) SENSOR B connector

8-pole connector for temperature SENSOR B. This connector also provides the POWER OUTPUT (**20/21**) for the heating unit (max. $\pm 12\text{V DC}$ and 3A) for devices with the ALA DIN connector cable assembly. (e.g. HCMIS, see www.alascience.com).

(24) COMMAND INPUT 10mV/°C connector

BNC connector to set the working temperature of the controller system by an external voltage signal. This input is scaled with the factor 10mV / °C.

(23) DESIRED TEMP./°C potentiometer

Digital potentiometer to set the working temperature of the controller system for channel B, range: 05.0 °C to 60.0 °C, XX.X °C or 0-100% of output voltage (DIRECT mode).

(32,33 / 20,21) BIPOLAR POWER OUTPUT MAX 3A connectors

Banana jack connectors for the heating units (**32,33** for channel **A** - **20,21** for channel **B**). These outputs supply a maximum voltage of 12V DC and a maximum current of 3 A.

POWER OUTPUT is also available at the SENSOR A (**28**) and SENSOR B connectors (**25**) for devices with the ALA DIN cable assembly.

(31, 22) OUTPUT 10mV / °C connector

BNC connector monitoring the temperature determined by SENSOR A (28) or SENSOR B (25) respectively, sensitivity: 10mV / °C.

(34) SHUTOFF TEMPERATURE label

Label indicating the upper SHUTOFF TEMPERATURE (standard is 60 °C). If the sensor measures the indicated temperature or more the POWER OUTPUT is disabled.

3.3. Rear Panel Elements

LINE VOLTAGE SELECTION: The selector for the line voltage and the connector for the power cord are located in a mains connection module on the rear panel of the instrument.

Caution: If operated with other line voltage the instrument may be damaged if the wrong line fuse is installed!

FUSE: The fuse is also integrated in the mains connection module. The line fuse must be 4 A slow (115 V) or 2 A slow (230 V). It must be replaced only by specified type (see above). Please disconnect mains power plug before replacing fuse.

3.4. Electronic Control and Protection Circuits**CONTROL LOOP**

The sensor / thermometer, PI-controller, output power stage and Peltier element form a closed loop control system. The desired temperature signal is compared with the output signal obtained from the thermometer giving an error signal. This signal is amplified in the PI controller and transferred to the output stage where it is converted to a high-power output signal applied to the Peltier element.

ELECTRONIC PROTECTION CIRCUITS

Each system is equipped with two protection systems:

1. Sensor inputs: an electronic shut-off function disconnects the output if the sensor is disconnected, broken or short-circuited.
2. Output protection: the output current and voltage are limited electronically.

Important: The sensors used for the control must be in good thermal connection with the Peltier elements; if not, unstable operation and damage may occur.

ALARM circuit

The internal thermometer (R2252 or PT100 sensor) inputs are protected by the sensor alarm circuit (see above). If this thermometer is used as input device for the PI controller, the ALARM circuit disconnects the power output if the sensor is damaged or not connected. This state is indicated by the red ALARM LED. If the DIRECT mode or EXT mode is used the ALARM circuit is disabled.

ACCURACY

Measuring accuracy of the internal thermometer is 0.1°C, controller accuracy is 0.5°C or better (depending on the amount of heated solution).

3.5. Connection of Peltier Elements

The PTC-20 is designed to work with Peltier elements. Peltier elements have two different sides: one is the “active” side and the other is the “opposite” side (usually marked as “active” and “opposite” respectively). In order to work properly the Peltier elements have to be connected with right polarity to the PTC-20.

Quick installation for channel A:

- Connect the “active” side to the + pole (33, Figure 1)
- Connect the “opposite” side to the - pole (32, Figure 1)
- Mount the Peltier element on a heat sink (the “opposite” side facing the heat sink).
This is very important especially if you use the Peltier element for cooling, because in cooling mode the “opposite” side gets hot!!

or

- Connect a Peltier element using an ALA DIN cable to the SENSOR connector (28, Figure 1). The right polarity is ensured automatically.

Now it is ensured that the “active” side gets hot if the MODE switch (8, Figure 1) is set to HEAT and cold if the MODE switch (8, Figure 1) is set to COOL in DIRECT mode. The right polarity is also very important for all other operation modes (see chapter 3.6).

Note: The POWER OUTPUT line of the SENSOR connectors is always operating for the channel which is selected, regardless of the MODE OF OPERATION (see chapter 3.6).

3.6. Modes of Operation

Each channel of the system can be used in the following modes of operation.

- | | |
|-----------------------|--|
| DIRECT MODE: | output voltage is set directly by the DESIRED TEMP. °C control. |
| Internal SENSOR mode: | output voltage is controlled by the PI controller using SENSOR A or SENSOR B. |
| EXT. SENSOR mode: | output voltage is controlled by the PI controller using an external thermometer. |

DIRECT mode

In DIRECT mode (no temperature control): the MODE switch (**8** (channel **A**) or **12** (channel **B**), Figure 1) is set to one of the two DIRECT positions:

DIRECT HEAT position sets the output voltage positive (referring to ground)

DIRECT COOL position sets the output voltage negative (referring to ground).

In both DIRECT modes the control unit is not active, i.e. the output voltage is preset directly at the DESIRED TEMP. control (**30** (channel **A**) or **23** (channel **B**, Figure 1). With the setting from 000 to 999 the output voltage increases linearly from 0 V to +12 V (DIRECT HEAT) or 0 V to -12 V (DIRECT COOL). The ALARM circuit (see below) is disabled in this mode.

Note: In DIRECT COOL mode there will not occur any output voltage when the HEAT ONLY toggle switch is activated!

DIRECT HEAT and DIRECT COOL will work in this way only if the Peltier element is connected to the PTC-20 with right polarity!

HEATING / COOLING OPERATION in DIRECT mode

The PTC system is designed with bipolar outputs (0 V to ± 12 V DC). If a resistive load is connected the system can be used for heating purposes in all modes (CONTROL and DIRECT). If a PELTIER device is connected to the output, the system can be used either for heating or cooling purposes ("active" side of the Peltier device in contact with recording chamber). If a Peltier device is used for cooling purposes, the "opposite" (hot) side of the Peltier element must be connected to an adequate heat sink.

Caution: When using COOL DIRECT mode check the position of the HEAT ONLY toggle switch (position is also indicated by the red HEAT ONLY LED). In any case cooling function is only possible when this switch is not activated!

Internal SENSOR mode

In this mode the output voltage is controlled by the PI controller (PI [proportional-integral controller system] activated). The temperature signal which is used for the control unit is SENSOR A for channel **A** and SENSOR B for channel **B**. The temperature is measured with a small semiconductor or PT100 sensor connected to SENSOR A and / or to SENSOR B and displayed at the respective digital display unit (**7** or **14**, Figure 1, XX.X °C).

If no sensor is connected or if the sensor is damaged or short circuited the internal shut-off unit disconnects the power output. This state is indicated by the red ALARM LED (**9** or **13**, Figure 1) located just above the MODE switch.

Caution: The temperature sensors are very sensitive to mechanical stress, especially to bending. Therefore, they must be handled with great care to avoid breaking of the insulation!

EXT. SENSOR mode

This mode can be used to connect an external thermometer. The calibration of the external input (EXT. SENSOR 1mV / °C, (**10** or **26**, Figure 1)) is 1 mV / °C. If this option is used the internal ALARM circuits are disabled.

POWER OUTPUT is always available at POWER OUTPUT and SENSOR A or SENSOR B, respectively.

Figure 5 gives an overview of the operation modes of the PTC-20.

3.7. Setting the *DESIRED TEMPERATURE*

There are two ways to set the *DESIRED TEMPERATURE*:

1. The easiest way is to use the digital potentiometer *DESIRED TEMP. / °C*. The temperature can be set from +03.0 °C to +60.0 °C, resolution: 0.1 °C. If the PTC-20 leaves this temperature window the internal shut-off unit disconnects the power output. This could be the case if the sensor is broken or short-circuited.
2. If the user wants to have external control (e.g. with a computer system) the *DESIRED TEMPERATURE* can be set using the *COMMAND INPUT 10mV / °C* connector (**29** or **24**, Figure 1). The *COMMAND INPUT* is scaled 10mV / °C, i.e. +370 mV at this connector would set the *DESIRED TEMPERATURE* to +37 °C.

Important: The set value of the temperature is always the sum of the setting at *DESIRED TEMP. / °C* potentiometer and the voltage at *COMMAND INPUT 10mV / °C* connector, i.e. if *DESIRED TEMP. / °C* is set to +25.0 °C and the voltage at *COMMAND INPUT 10mV / °C* is +150 mV the temperature will be set to +40 °C !!

4. Grounding

To avoid ground loops, the internal ground of the system is floating, i.e. it is not connected to the protective earth of the mains while the cabinet is always connected to protective earth (green / yellow wire). The system can be grounded either via a BNC cable connected to *INPUT* or *OUTPUT* (10 mV / °C) or via the blue *OUTPUT (= GND)* connector.

5. Temperature sensors / Block diagram

5.1. DIN Connector

Cable of temperature sensor for PTC / MTC / TC

length : 2m

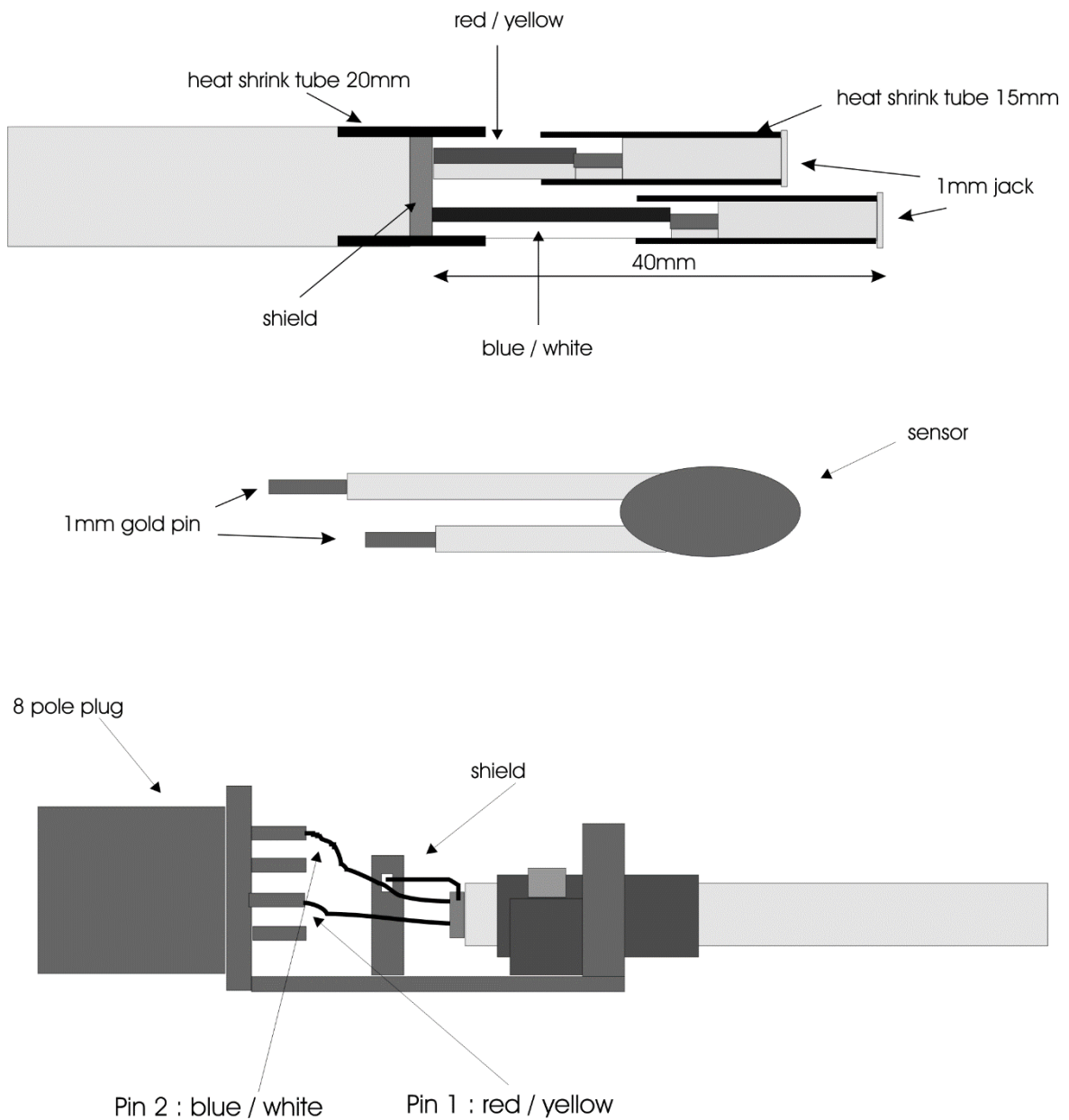

Figure 2: How to connect the temperature sensor

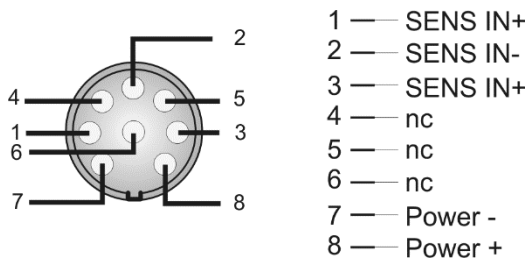

Figure 3: Connector pinout of the DIN connector (pins 1 and 3 are connected internally)

5.1. Available sensors



Figure 4: Temperature sensors and cable.

The sensors come with a connection cable (TS-CAB, see Figure 4, left) with a DIN connector on one end and two 1 mm connectors on the other end. The DIN connector is for connection to the SENSOR input at the front panel of the temperature controller. The 1 mm connector are for connection of the sensor, which is available as spare part.

There are two sensors available: the white TS-100S (Figure 4right, top) and the dark TS-200S (Figure 4 right, bottom).

Important: The TS-100S has a special coating that makes it mechanically stable and waterproof. The TS-200S is optimized for size. Its coating might get leaky after mechanical stress (e.g. bending of the wires).

Dimensions:

TS-100S: 2.5 mm x 6 mm

TS-200S: 0.8 mm x 6 mm

5.2. Block diagram

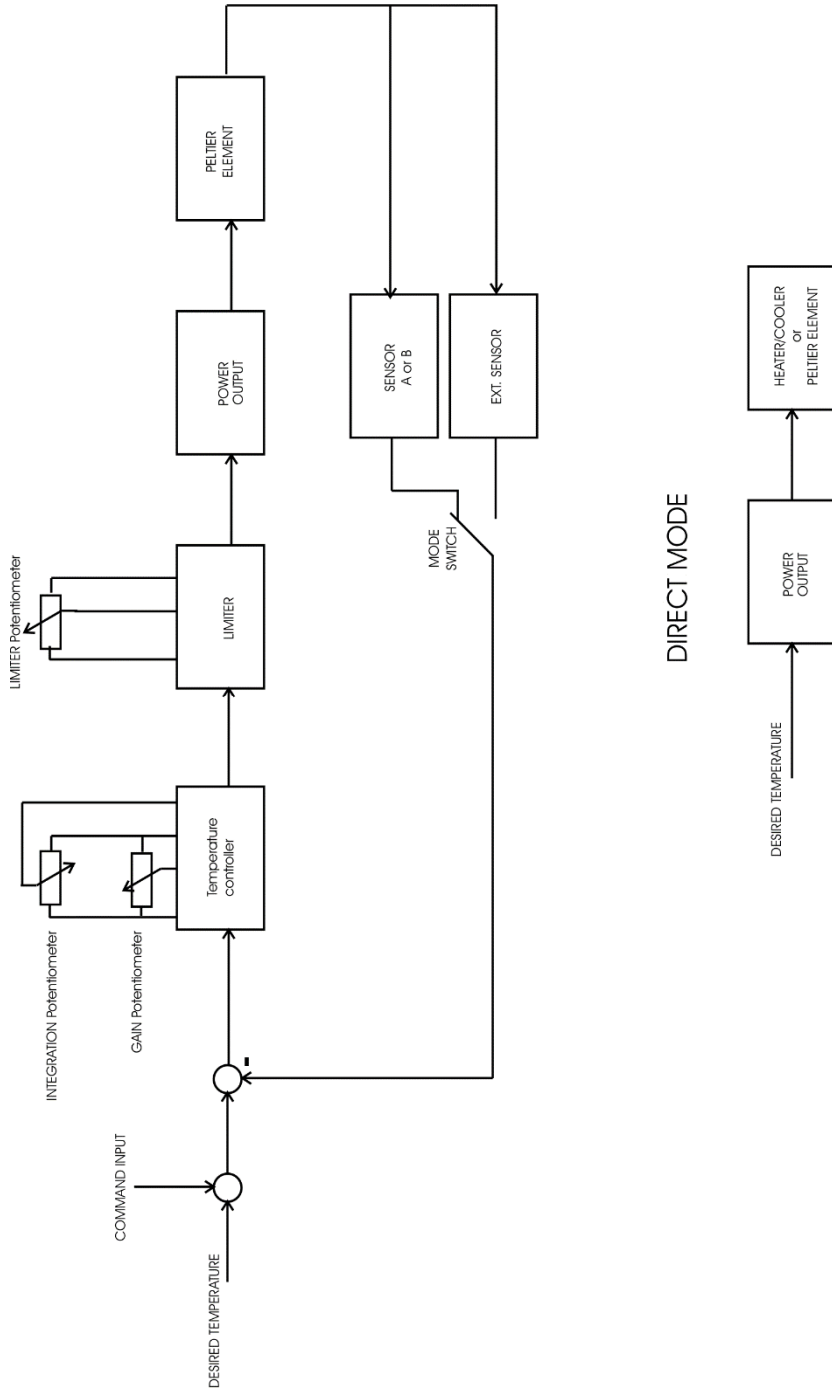

Figure 5: Block diagram of the PTC-20

6. Operating guide – Tuning procedure

After unpacking the instrument please check the appropriate voltage at the voltage selector at the back panel. Also check that the sensor used for the control is in good thermal connection with the heating wire or the “active” side of the Peltier element and that the Peltier element is connected with right polarity (see chapter 3.5).

Important: Make sure that the SENSOR or the external SENSOR, respectively, and the heating device / Peltier element that is controlled by this SENSOR are using the same channel. Otherwise the heating device/ Peltier element may be damaged due to overheating.

In the following it is assumed that you use devices delivered by npj or ALA Scientific Instr. with 12V operating voltage. Please follow these instructions step by step to avoid problems in adjusting the instrument.

- Turn all potentiometers to the most left position
- switch the MODE selector to the position SENSOR A or B depending on which sensor is used as feedback temperature in the controller loop
- set the DESIRED TEMPERATURE to e.g. 37 °C

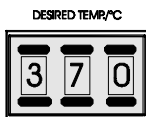

turn on the instrument and wait at least 15 minutes to warm up the instrument. The temperature display should show the actual temperature at the sensor

- turn the LIMITER to 100%

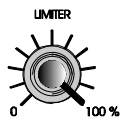

Note: If you use heating wires with 6V operating voltage turn the LIMITER to 50% to protect the wire from damage.

If the difference between the actual and the desired temperature is more than 10 °C the HEAT-LED will light up slightly.

- turn the GAIN to the seventh scale mark



The actual temperature at the sensor now approaches the desired temperature but will not reach 37 °C, because the control loop is not yet well adjusted. The actual temperature will arrest at 1 to 2 °C below the desired temperature. Please wait until this steady state value is reached. This may last several minutes. If you don't get a steady state value, set the LIMITER to 80-90% (or 30-40%, respectively) and wait again.

- Now turn on the INTEGRATION and set it approximately to the first scale mark. You will hear a “Click” if the INTEGRATION gets active.



The actual temperature at the sensor will now reach the desired temperature possibly after a small overshoot. Wait again until the steady state value is reached. If this value is not reached set the GAIN to higher levels until - in this example - 35 °C to 35.5 °C is reached.

- If the desired temperature is not reached first set the GAIN to a slightly higher level and then – if necessary – raise the INTEGRATION (see Figure 6).

Note: The speed of the control circuit (and therefore the time in which the actual temperature reaches the DESIRED TEMPERATURE) is highly dependent on the first settings of GAIN and INTEGRATION. Thus, when beginning to use the PTC-20 we recommend to try out several first settings of GAIN and INTEGRATION to find out which settings are best for your experimental conditions.

If you use a perfusion system and you are going to heat it is recommended to heat the solution approximately to the desired temperature **before** perfusing the bath either with a heated perfusion tube (HPT-2A, available from npj) or by heating up the supplying bowl.

As mentioned above it is very important that the sensor element and the heating / cooling element are in good thermal connection.

In Figure 6 the time course of temperature regulation of the PTC-20 (channel A) is shown. As resistive load a bulb (12V, 21W) was used. The temperature sensor was fixed directly on the bulb and sensor and bulb were wrapped with foam. Starting temperature was 27,3 °C. Starting conditions were: LIMITER set to 0, GAIN set to 0, INTEGRATION off.

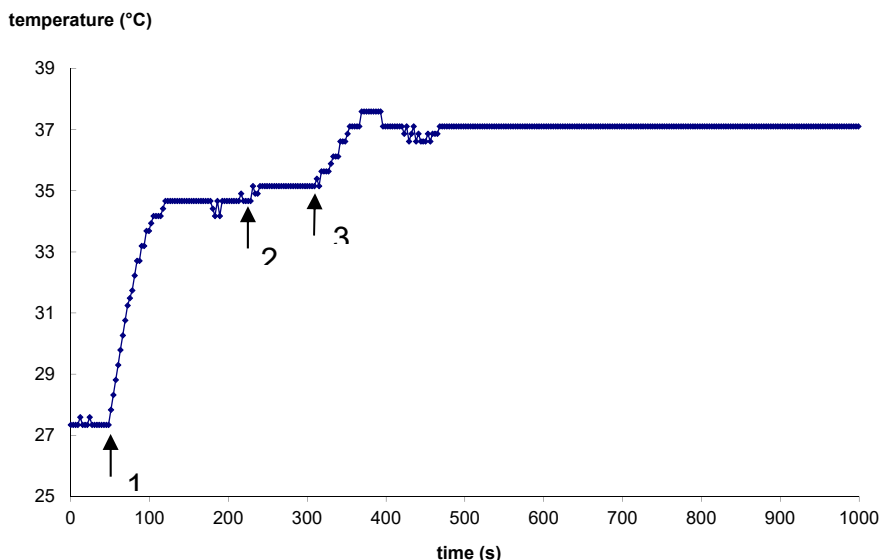

Figure 6: Time course of temperature regulation of the PTC-20, channel A.
 1: LIMITER was set to 100%, GAIN was set to the seventh scale mark
 2: GAIN was set to the eighth scale mark
 3: INTEGRATION was turned on at a low level

6.1. PTC-20 and the HCMIS Micro-Incubator

Connection

Connect the HCMIS using the ALA DIN cable to one of the SENSOR connectors (**28** or **25**, Figure 1). The right polarity is ensured automatically.

Operation

Heating

Follow the steps as described above. With the HCMIS micro-incubator from ALA Scientific Instr. it is likely that you have to use more gain in order to reach a steady state temperature of 35 °C to 36 °C without INTEGRATION. In that case increase the gain stepwise and wait in every step until the temperature reaches a steady state level of 35 °C to 36 °C and then turn on the INTEGRATION as described above (see also Figure 7).

Cooling

It is characteristic for Peltier elements that when they cool on one side the other side gets very hot. When cooling the upper side of the HCMIS gets hot and it must be ensured that the heat from the upper side is carried off. This is best done by using the fluid cooling system of the HCMIS. Without cooling the HCMIS with fluid it is not possible to reach temperatures below 20 °C.

Caution: When operating the HCMIS in cooling mode always use the fluid cooling system to avoid overheating and damage of the Peltier elements.

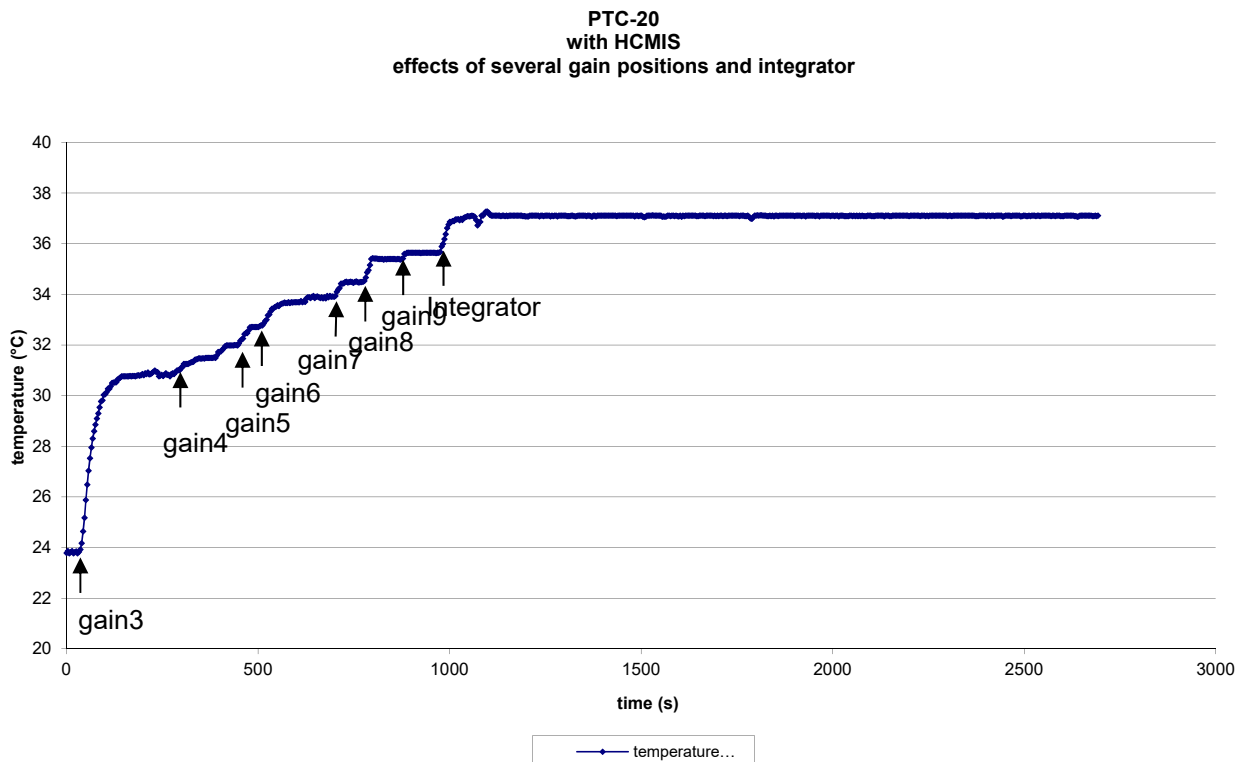

Figure 7: Time course of temperature regulation of the PTC-20, HCMIS micro-incubator connected to channel A

6.2. Operation with HPT-2A Heated Perfusion Tube (discontinued)

For use with HPT-2A from ALA please follow these hints.

- Always use the LIMITER. Do not set the LIMITER to more than 40% for a longer time, since the HPT-2A will melt if operated at more than 5V. If in doubt, measure the output voltage using a voltmeter.
- Do not heat the HPT-2A without flow of solution. See also HPT-2A manual.

7. Literature

Kettenmann, H. and R. Grantyn (eds.) Practical Electrophysiological Methods, Wiley-Liss, New York 1992

Froehr, F. and F. Orttenburger Introduction to Electronic Control Engineering, Siemens AG, Berlin and Munich 1982

8. Technical Data

<u>Sensor input:</u>	for semiconductor 2252 Ω at 25 °C (standard) or platinum 100 Ω at 0 °C, accuracy typically 0.1 °C at 25 °C, with electronic protection
<u>Sensor input (EXT. Mode):</u>	1mV / °C
<u>ALARM and SHUTOFF:</u>	disconnects POWER OUTPUT if temperature is below +3 °C (not connected or broken sensor) or above +60 °C (short circuited sensor) , other ranges possible
<u>Digital displays:</u>	3 1/2 digits, XX.X °C (temperature of SENSOR A or B) or XX.X V (voltage at power output)
<u>COMMAND INPUT:</u>	analog input, 10mV / °C, via BNC connector
<u>Set value control:</u>	digital control, range: 03.0 °C to 60.0 °C (other ranges possible), XX.X °C or 0-100% of output voltage (DIRECT modes)
<u>Temperature OUTPUT (A, B):</u>	analog outputs, 10mV / °C, via BNC connector, output impedance: 250 Ω
<u>Power output:</u>	± 12 V / 3 A for each channel, short circuit protected, continuous DC
<u>Limiter:</u>	control for the output voltage with a linear range from 0 – 100 %
<u>Control:</u>	PI (proportional-integral) controller, accuracy typically ± 0.2 °C, gain range 10 - 10k, integration time 50 ms - 20 s (logarithmic scale)
<u>Measuring accuracy:</u>	0.1 °C at 25 °C
<u>Power requirements:</u>	115 / 230V AC, 60 / 50 Hz, fuse 4 / 2A slow
<u>Dimensions:</u>	19" rackmount cabinet 19" (483 mm), 10" (250 mm), 3.5" (88 mm)